



Applications

- Phase Control
- Static Switching
- Light Dimming
- Motor Speed Control
- Kitchen Equipment
- Power Tools
- Solenoid Valve Controls:
 - Dishwashers
 - Washing Machines

- > **Suitable for General Purpose AC Switching**
- > **Alternistor/No Snubber Versions for Inductive Loads**
- > **Logic Level Available for use with Microcontrollers and Low Level Devices**
- > **IGT Range 5-50 mA (Q1)**
- > **V_{DRM}/V_{RMM} 400, 600, 800, 1000V**

CTA/CTB12

12Amp - 400/600/800/1000V - TRIAC

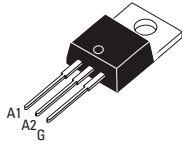

TO-220AB Isolated (CTA12)

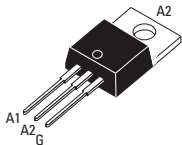

TO-220AB Non-Isolated (CTB12)



Absolute Maximum Ratings

	CONDITIONS	SYMBOL	RATING
RMS On-State Current (full sine wave)	T _c = 105°C T _c = 90°C	TO-220AB TO-220AB Iso	I _{T(RMS)} 12A
Non Repetitive Surge Peak On-State Current (Full Cycle, T _j Initial = 25°C)	F = 50 Hz F = 60 Hz	I _{TSM}	120A 126A
I ² t Value for fusing	tp = 10 ms	I ² t	78A ² s
Critical rate of rise of on-state current I _G =2 x I _{GT} , tr<100ns, T _j = 125°C		di/dt	100A/μs
Peak Gate Current @ T _j = 125°C	tp = 20 μs	I _{GM}	4A
Average Gate Power Dissipation @ T _j = 125°C		P _{G(AV)}	1W
Storage Temperature Range		T _{stg}	-40 to +150°C
Operating Junction Temperature Range		T _j	-40 to +125°C
Isolation Voltage (CTA Series only)		V _{ISO}	2500 V _{RMS}

Electrical Characteristics

ALTERNISTOR/NO SNUBBER AND LOGIC LEVEL (3 Quadrants)		TW	SW	CW	BW
I _{GT} MAX @ V _D = 12 V, R _L = 30Ω NOTE 1	QI-II-III	5mA	10mA	35mA	50mA
V _{GT} MAX @ V _D = 12 V, R _L = 30Ω	QI-II-III	1.3V	1.3V	1.3V	1.3V
V _{GD} MIN @ V _D = V _{DRM} , R _L = 3.3kΩ	T _j = 125°C QI-II-III	0.2V	0.2V	0.2V	0.2V
I _H MAX @ I _T = 500 mA NOTE 2		10mA	15mA	35mA	50mA
I _L MAX @ I _G = 1.2 I _{GT}	QI-III	10mA	25mA	50mA	70mA
I _L MAX @ I _G = 1.2 I _{GT}	Q-II	15mA	30mA	60mA	80mA
dv/dt MIN @ V _D = 67%V _{DRM} (gate open) NOTE 2	T _j = 125°C	20V/μs	40V/μs	400V/μs	1000V/μs
(di/dt) _c MIN @ (dv/dt) _c = 0.1 V/ms NOTE 2	T _j = 125°C	3.5A/ms	5.4A/ms		
(di/dt) _c MIN @ (dv/dt) _c = 10 V/ms NOTE 2	T _j = 125°C	1A/ms	2.9A/ms		
(di/dt) _c MIN without Snubber NOTE 2	T _j = 125°C			6.5A/ms	12A/ms

STANDARD (4 Quadrants)

		C	B
I _{GT} MAX @ V _D = 12 V, R _L = 30Ω NOTE 1	QI-II-III	25mA	50mA
I _{GT} MAX @ V _D = 12 V, R _L = 30Ω NOTE 1	QIV	50mA	100mA
V _{GT} MAX @ V _D = 12 V, R _L = 30Ω	Q-AII	1.3V	
V _{GD} MIN @ V _D = V _{DRM} , R _L = 3.3kΩ	T _j = 125°C Q-AII	0.2V	
I _H MAX @ I _T = 500 mA NOTE 2		25mA	50mA
I _L MAX @ I _G = 1.2 I _{GT}	QI-III-IV	40mA	50mA
I _L MAX @ I _G = 1.2 I _{GT}	Q-II	80mA	100mA
dv/dt MIN @ V _D = 67%V _{DRM} (gate open) NOTE 2	T _j = 125°C	200V/μs	400V/μs
(dv/dt) _c MIN @ (di/dt) _c = 2.7 A/ms NOTE 2	T _j = 125°C	5V/μs	10V/μs

GENERAL NOTES

1. Minimum IGT is guaranteed at 5% of IGT max.
2. For both polarities of A2 referenced to A1
3. All parameters at 25 degrees C unless otherwise specified.



Static Characteristics

V_T MAX @ $I_{TM} = 17$ A, $t_p = 380\mu s$ NOTE 2	$T_j = 25^\circ C$	1.55V
V_{to} MAX @ Threshold Voltage NOTE 2	$T_j = 125^\circ C$	0.85V
R_d MAX @ Dynamic Resistance NOTE 2	$T_j = 125^\circ C$	35m Ω
I_{DRM} MAX @ $V_{DRM} = V_{RRM}$	$T_j = 25^\circ C$	5 μ A
I_{RRM} MAX @ $V_{DRM} = V_{RRM}$	$T_j = 125^\circ C$	1mA

Thermal Resistances

	SYMBOL	RATING
Junction to Case (AC)	$R_{th(j-c)}$	1.4 $^\circ C/W$
Junction to Case (AC)	$R_{th(j-c)}$	2.3 $^\circ C/W$
Junction to Ambient	$R_{th(j-a)}$	60 $^\circ C/W$
Junction to Ambient	$R_{th(j-a)}$	60 $^\circ C/W$

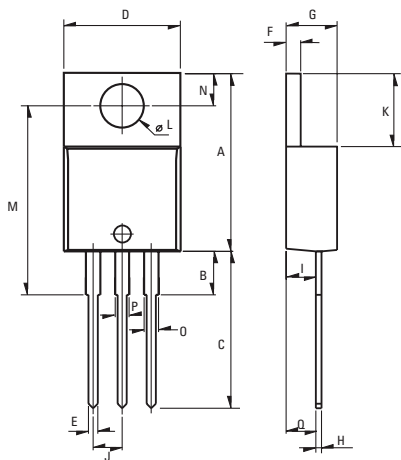

Weight: 2.3g (0.08 oz)

Dimensions

REF.	Millimeters			Inches		
	Min.	Typ.	Max.	Min.	Typ.	Max.
A	15.24		15.75	0.6		0.62
B		3.23			0.127	
C	12.78		13.79	0.503		0.543
D	9.96		10.36	0.392		0.408
E	0.69		0.94	0.027		0.037
F	1.22		1.32	0.048		0.052
G	4.62		4.83	0.182		0.19
H	0.46		0.61	0.018		0.024
I	2.49		2.84	0.098		0.112
J	2.39		2.69	0.094		0.106
K	6.48		6.88	0.255		0.271
L	3.78		3.89	0.149		0.153
M	15.49	16	16.51	0.61	0.63	0.65
N	2.59		2.9	0.102		0.114
O	0.99		1.55	0.039		0.061
P	0.99		1.55	0.039		0.061
Q		2.67			0.105	

Part Number Selection

Part Number	Voltage [Vpk]	I_{GT} [mA]	Type	Package
CTA/CTB12-xxxB	400, 600, 800, 1000	50mA	Standard	TO-220AB
CTA/CTB12-xxxBW	400, 600, 800, 1000	50mA	Alternistor/No Snubber	TO-220AB
CTA/CTB12-xxxC	400, 600, 800, 1000	25mA	Standard	TO-220AB
CTA/CTB12-xxxCW	400, 600, 800, 1000	35mA	Alternistor/No Snubber	TO-220AB
CTA/CTB12-xxxSW	400, 600, 800, 1000	10mA	Logic Level	TO-220AB
CTA/CTB12-xxxTW	400, 600, 800	5mA	Logic Level	TO-220AB

Part Number Designation

SERIES
CT **B** **12** - **800** **CW** **PT**

Type
B: Standard ($I_{GT} = 50$ mA)
BW: Alternistor/No Snubber ($I_{GT} = 50$ mA)
C: Standard ($I_{GT} = 25$ mA)
CW: Alternistor/No Snubber ($I_{GT} = 35$ mA)
SW: Logic Level ($I_{GT} = 10$ mA)
TW: Logic Level ($I_{GT} = 5$ mA)

Rated Current
12: 12 Amp

Maximum Blocking Voltage
400: 400Vpk
600: 600Vpk
800: 800Vpk
1000: 1000Vpk

Packaging
Blank: Bulk
PT: Plastic Tube

Isolation Type
A: Isolated
B: Non-Isolated

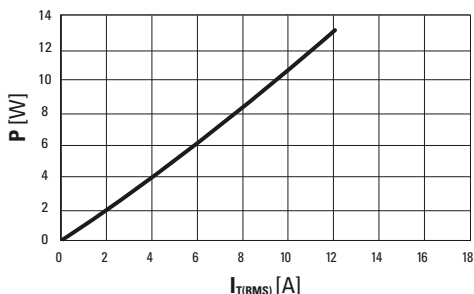

Fig. 1: Power dissipation versus RMS on-state current (full cycle).

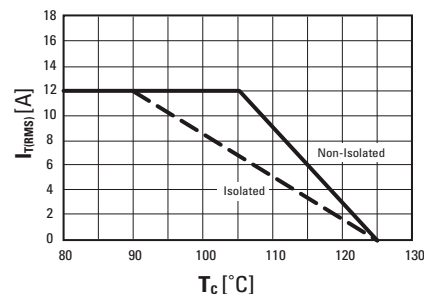

Fig. 2: RMS on-state current versus case temperature (full cycle)

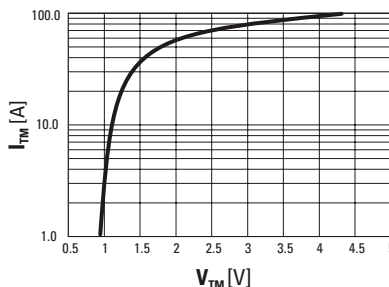

Fig. 3: On-state current versus on-state voltage (instantaneous values)

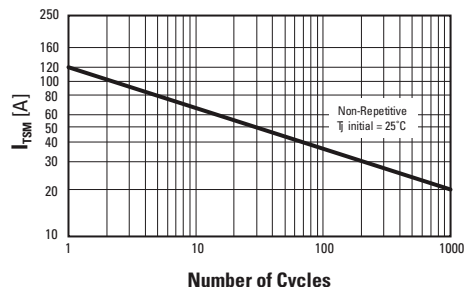

Fig. 4: Non-repetitive surge peak on-state current versus number of cycles.

ISO9001 Certified

© 2007 C3 Semiconductors, Specifications subject to change without notice.

Approvals

UL Recognized Component - E72445
(For CTA series)

For recommended applications and more information contact:

USA: Sales Support (888) 882-8689
 C3 Semiconductors, LLC. 2320 Paseo de las Americas, Ste. 104, San Diego, CA 92154
 Email: sales@c3semi.com WEB SITE: http://www.C3semi.com